

SK NÁVOD NA MONTÁŽ  
 CZ MONTÁŽNÍ NÁVOD  
 HU SZERELÉSI UTASÍTÁS  
 DE MONTAGEANLEITUNG

# MAURUS NEW MA 50

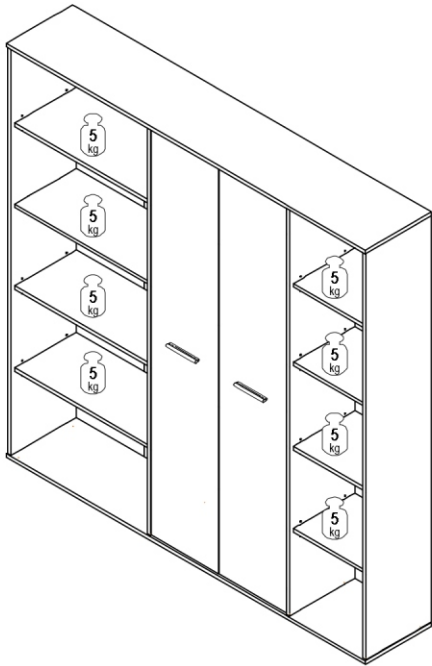

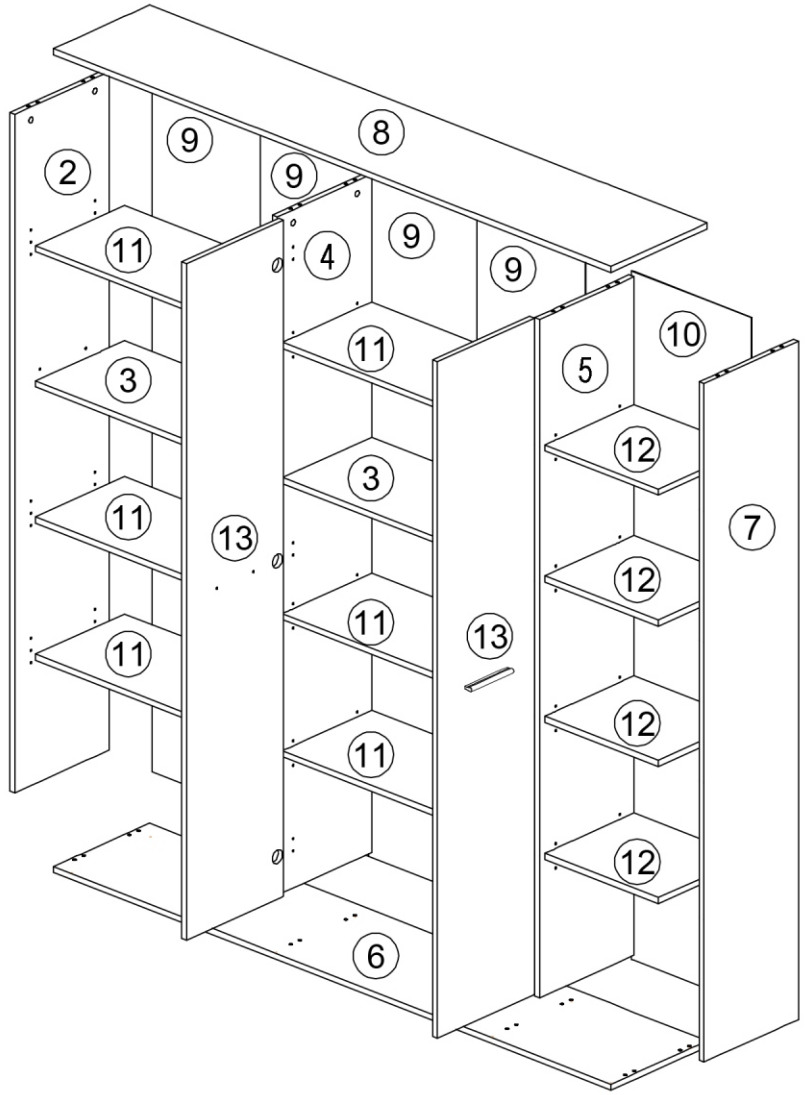





	1812
	1812
	335

ID	ID			
12438	②	1780*330*16	1x	1/3
12439	③	687*311*16	2x	1/3
12440	④	1780*330*16	1x	1/3
12441	⑤	1780*330*16	1x	1/3
12442	⑥	1812*335*16	1x	2/3
12443	⑦	1780*330*16	1x	1/3
12444	⑧	1812*335*16	1x	2/3
12445	⑨	352*1806*2,5	4x	3/3
12437	⑩	389*1806*2,5	1x	3/3
12446	⑪	687*311*16	6x	2/3
12434	⑫	368*311*16	1x	1/3
12434	⑫	368*311*16	3x	2/3
12435	⑬	1774*339*16	2x	3/3





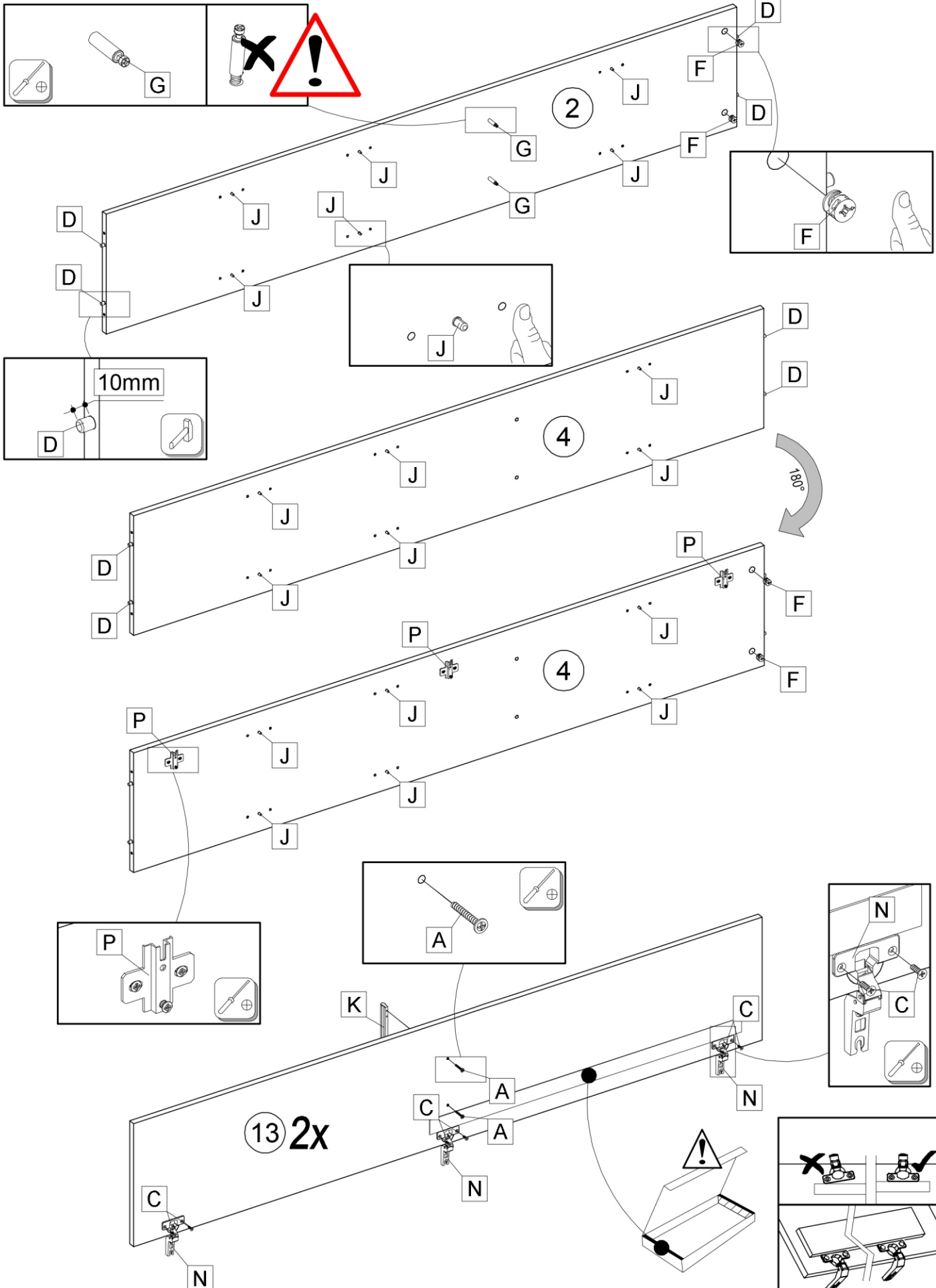

22430,00  Ø4x25	22244,01  Ø3,5*16	22243,00  Ø3,5x15	27000,00  Ø8*30	E 	70013,01 	70021,01 	22300,00  Ø7x50	35101,01 	32030,00 
A 4x	B 2x	C 12x	D 16x	E 16x	F 16x	G 12x	H 8x	J 40x	K 2x
22236,00  Ø2,5x16	24008,00  3,0	36001,01 	36001,01 	21102,00  Ø1,2x20	70022,02 	34800,00 	22213,00  Ø4x70	24103,00  Ø8	31103,00 
L 26x	M 26x	N 6x	P 6x	Q 125x	R 2x	S 8x	T 1x	U 1x	V 1x

		180 min		PZ 2,1	4			3m	

																	
A	4x	C	12x	D	8x	F	4x	G	2x	J	18x	K	2x	N	6x	P	3x



				
D 8x	F 12x	G 10x	J 22x	P 3x

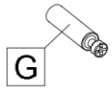
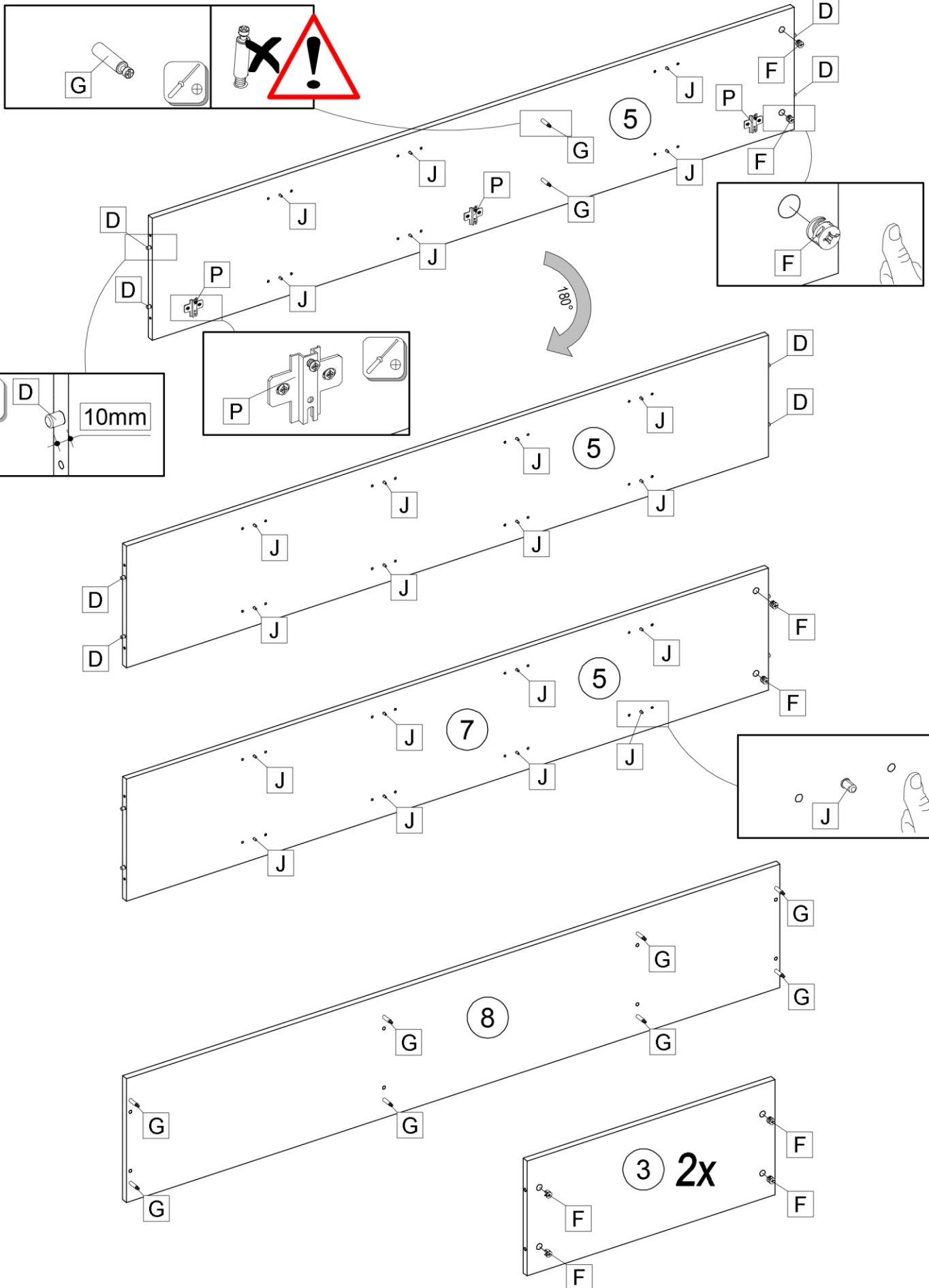

5

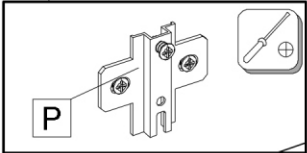
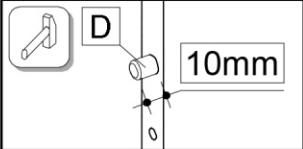
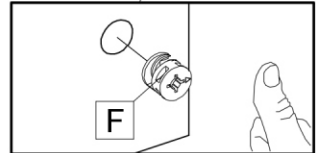

5

7

5

8

3 2x

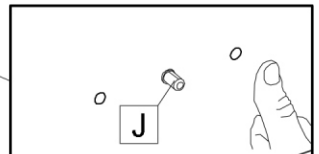

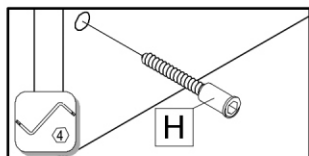
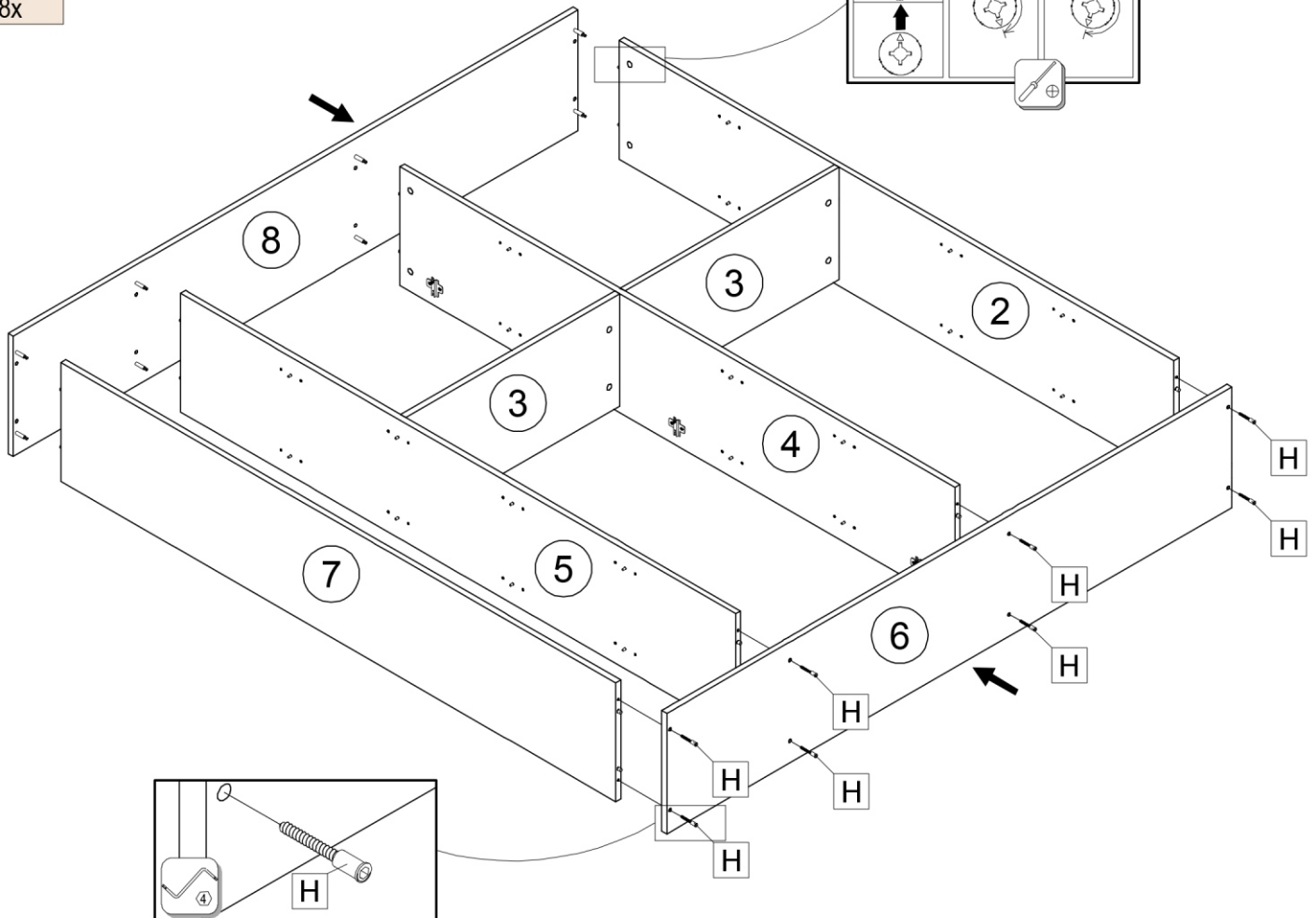
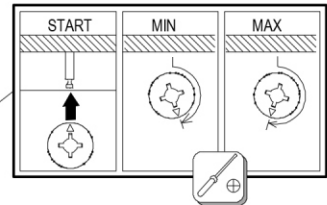
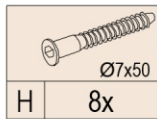
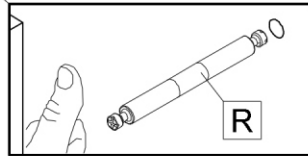
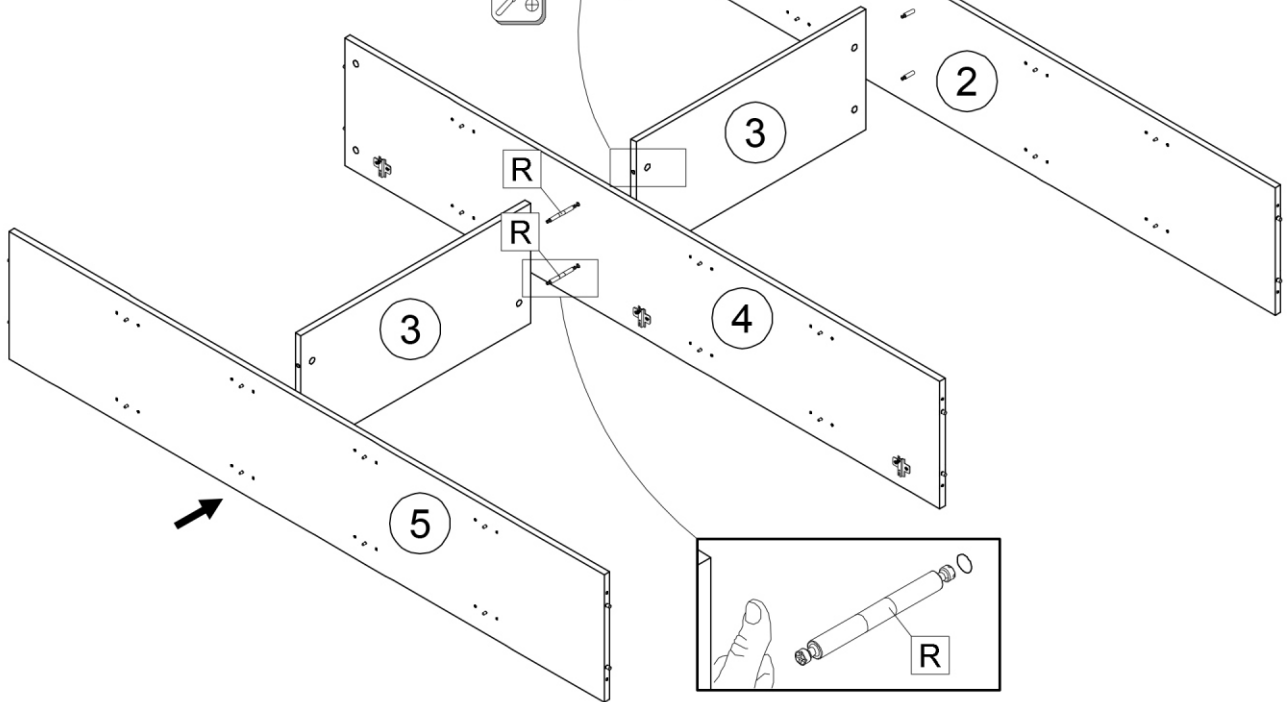
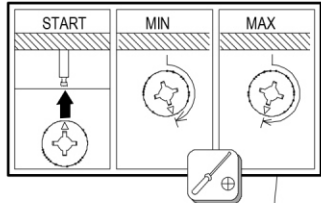
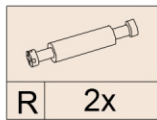



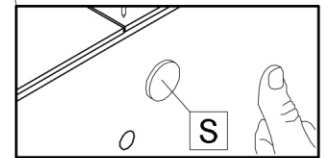
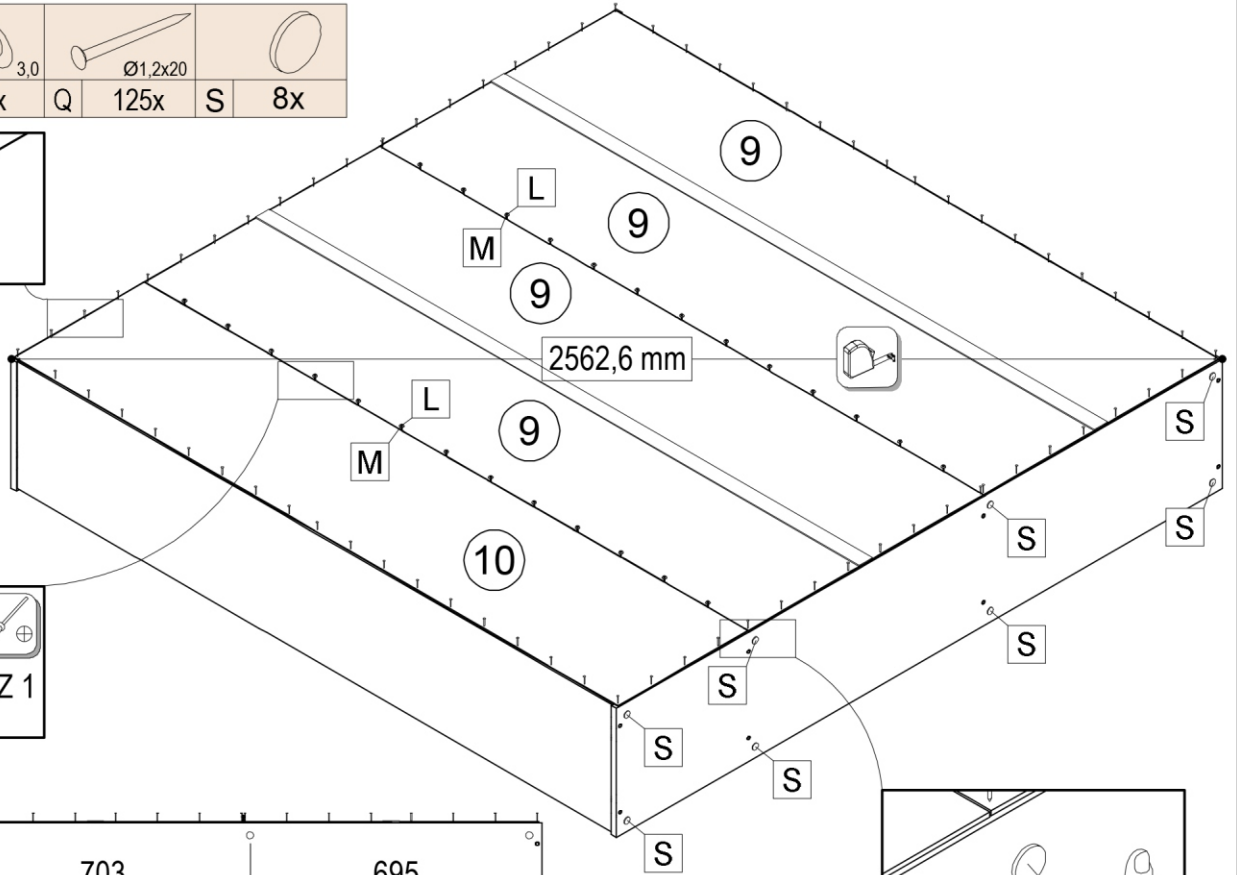
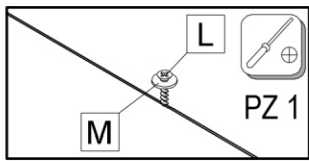
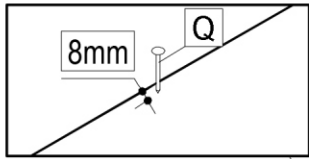

			
Ø2,5x16	3,0	Ø1,2x20	
L 26x	M 26x	Q 125x	S 8x

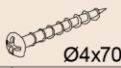
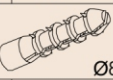

	
Ø3,5*16	Ø4x70
B 2x	T 1x
	
Ø8	
U 1x	V 1x

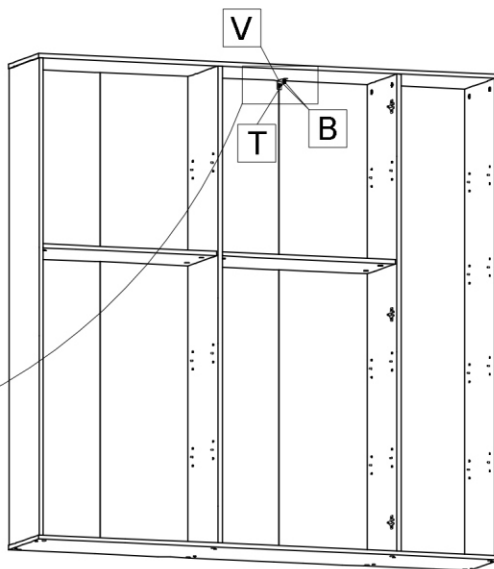
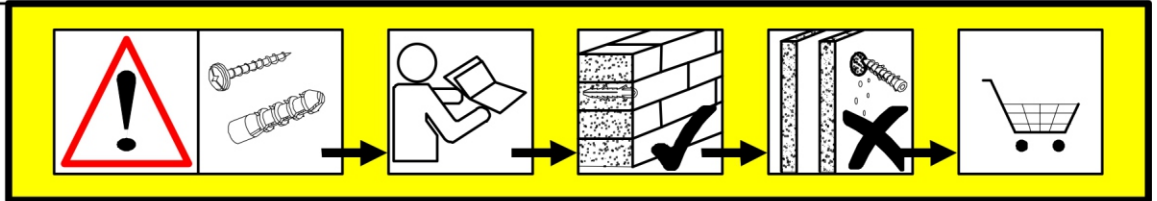
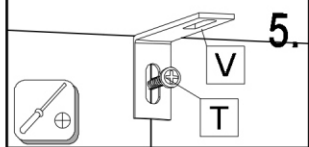
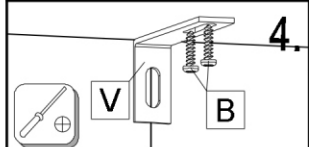
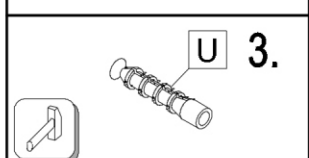
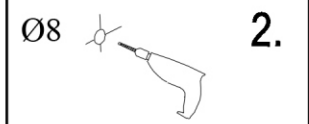
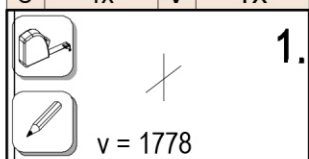

DE

Achtung! Die Wandbeschaffenheit ist vor der Montage unbedingt zu prüfen. Die beigelegten Universaldübel sind ausschließlich nur zur Verwendung für festes Mauerwerk wie Beton/Ziegel. Die Mauerdübel dürfen nicht bei Mauerwerk wie Hohlraumziegel, Leichtbausteinen, Gipskartonplatte oder anderer Rahmenbauweise verwendet werden. Bei diesen Mauerwerken sind gegebenenfalls Spezialdübel zu verwenden! Diese sind in einem Fachgeschäft (Baumarkt) erhältlich. Bei Nichteinhaltung wird seitens Produzenten/Händler und Importeur keine Haftung übernommen.

SK

Upozornenie! Pevnosť steny sa musí pred montážou bezpodmienečne skontrolovať. Univerzálne hmoždenky, ktoré sú obsiahnuté v balení, používajte jedine pre pevné murivo ako je betón/tehla. Hmoždenky sa nesmú používať v prípade ľahkého staveného muriva, dutina tehla, u sádkartónových dosiek alebo iných konštrukcií rámu. U týchto murív je nutné použiť špeciálne hmoždenky! Tieto je možné dostať v špeciálnych predajniach so stavebným materiálom (stavebniny). Pri nedodržaní pokynov nepreberajú výrobcovia/predajci a dodávateľia zodpovednosť za vzniknuté škody.

HU

Vigyázat! Szerelés előtt a falfelületet feltétlenül vizsgálja meg. A mellékelt univerzális tipli kizárólag stabil falazathoz használható mint például beton/tégla. A fal tipli nem használható könnyű építőkövek hez, üreg tégla, gipszkarton lapokhoz vagy más fávázás építményekhez. Ezekhez a falfelületekhez csak speciális tiplik használhatóak, melyek szaküzletekben (barkácsruházakban) beszerezhetőek. Fentiek figyelmen kívül hagyása esetén a gyártó/kereskedő vagy forgalmazó nem vállal felelősséget.

CZ

Upozornění! Před montáží je nutné zkontrolovat stav stěny. Příložené univerzální hmoždinky jsou určeny pouze k použití pro pevné zdivo jako beton/cihly. Hmoždinky do zdi se nesmí používat u dutinová cihla, zdiva jako pórovitý stavební kámen, sádkartónová deska nebo jiný měkký materiál. U těchto zdív jsou nutné použít speciální hmoždinky! Jsou k dostání v speciálních prodejnách se stavebním materiálem. Při nedodržení těchto pokynů výrobce/prodejece a dovozce neručí za způsobené škody.

  
E 16x

